



Owner's Manual

Original Instructions

Wired Controller for Exposed FCUs

Thank you for choosing commercial air conditioners. Please read this Owner's Manual carefully before operation and retain it for future reference.

If you have lost the Owner's Manual, please contact the local agent or visit www.gree.com or send an email to global@cn.gree.com for the electronic version.

GREE ELECTRIC APPLIANCES, INC. OF ZHUHAI

To Users

Thank you for selecting Gree's product. Please read this instruction manual carefully before installing and using the product, so as to master and correctly use the product. In order to guide you to correctly install and use our product and achieve expected operating effect, we hereby instruct as below:

- (1) This instruction manual is a universal manual, some functions are only applicable to particular product. All the illustrations and information in the instruction manual are only for reference.
- (2) All the illustrations and information in the instruction manual are only for reference. In order to make the product better, we will continuously conduct improvement and innovation without further notice.
- (3) For personal injury or property loss and damage caused by improper operation such as improper installation and debugging, unnecessary maintenance, violation of related national laws and rules and industrial standard, and violation of this instruction manual, etc., we will bear no liability.

Contents

Safety Notices	1
1 LCD	2
1.1 Icons of the LCD	3
1.2 Instructions to Icons	4
2 Press Buttons	6
2.1 External View of Press Buttons	6
2.2 Function Instructions to the Press Buttons	7
3 Installation of the Wired Controller	9
3.1 Dimensions and Parts of the Wired Controller	9
3.2 Installation Location and Requirements	10
3.3 Network Connection Instructions	11
3.4 Installation Instructions	12
3.5 Detachment of the Wired Controller	13
4 Operation Instructions	14
4.1 On/Off Setting	14
4.2 Mode Setting	15
4.3 Temperature Setting	15
4.4 Fan Speed Setting	15
4.5 Commissioning	16

4.6 Timer Setting.....	18
4.7 Sleep Function Setting.....	27
4.8 Turbo Setting.....	28
4.9 Save Function Setting.....	29
4.10 Quiet Function Setting	32
4.11 X-Fan Setting	33
4.12 Light Setting.....	33
4.13 Module State.....	34
4.14 Swing Setting.....	36
4.15 BMS Address Setting	37
4.16 Ambient Temperature	37
4.17 Other Functions	38
5 Error Display	41

Safety Notices

- (1) Each indoor unit should be powered with the same power supply.
- (2) Do not install the wired controller where it is damp or there is direct sunlight.
- (3) Never knock on, throw, or frequently detach the wired controller.
- (4) Do not operate the wired controller with wet hands.
- (5) Do not detach this wired controller on your own. When there is any problem, please contact the aftersales men.

1 LCD

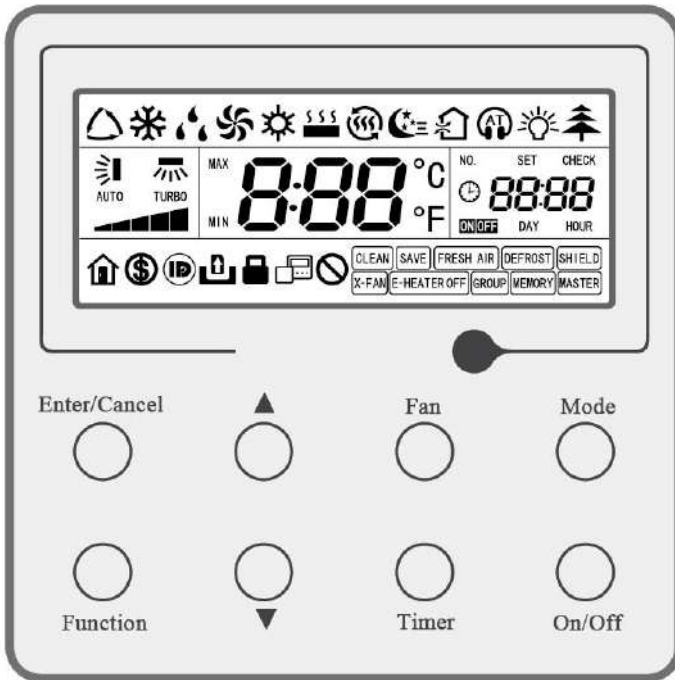

Figure 1.1 External View of the Wired Controller

1.1 Icons of the LCD

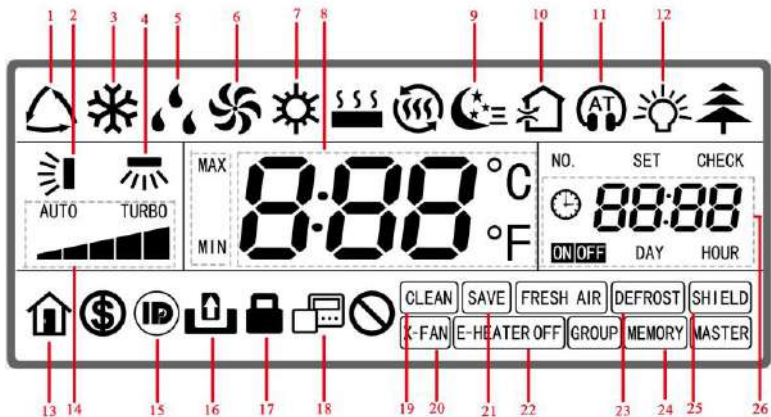

Figure 1.2 External View of the LCD

1.2 Instructions to Icons

Table 1.1 Instructions to Icons

No.	Icon name	Interpretation
1	Auto	It indicates the automatic mode. (In this mode, the indoor unit will automatically select the running mode according to the change of indoor temperature. This function is reserved temporarily.)
2	Up/down swing	It indicates the up/down swing function (hereinafter called swing function).
3	Cool	It indicates the cooling mode.
4	Left/right swing	It indicates the left/right swing function. (This function is reserved temporarily.)
5	Dehumidify	It indicates the dehumidifying mode.
6	Air supply	It indicates the air supply mode.
7	Heat	It indicates the heating mode.
8	Temperature display	It indicates temperature setting values.
9	Sleeping status	It indicates the sleeping status.
10	Air renewal	It indicates the air renewal status. (This function is reserved temporarily.)
11	Quiet	It indicates the quiet operation status (including “Imperative Quiet” and “Auto Quiet”). Wall-mounted type FCUs have “Quiet” function, but the cassette and floor ceiling types do not have it.

Wired Controller for Exposed FCUs

No.	Icon name	Interpretation
12	Light	It indicates the light function.
13	Holiday	It indicates the holiday function is available. (This function is reserved temporarily.)
14	Speed	It indicates fan speed settings (totally seven settings, including automatic, low, medium low, medium, medium high, high and turbo). (Cassette type FCUs have five speed settings: automatic, low, medium, high and turbo; the floor ceiling types have four speed settings: automatic, low, medium and high)
15	I-DEMAND	It indicates the comfort and energy saving function is available. (This function is reserved temporarily.)
16	Gate control	It indicates whether the access card was withdrawn or not.
17	Child lock	It indicates the child lock.
18	Master or slave wired control	It indicates the master or slave wired controller status. (This function is reserved temporarily.)
19	Clean	It alerts that the filter screen should be cleaned. (This function is reserved.)
20	X-fan	It indicates drying function.
21	Save	It indicates the energy saving status.
22	Auxiliary heating	It indicates auxiliary heating function.
23	Defrost	It indicates defrosting function.
24	Memory	It indicates the memory function is activated, that is, the unit will back to the previous set status after powered on again.

No.	Icon name	Interpretation
25	Shield	It indicates the shielded status.
26	Timer	It indicates the set timer.

Note: if some of the icons on the screen are not described here, the controller does not have corresponding functions.

2 Press Buttons

2.1 External View of Press Buttons

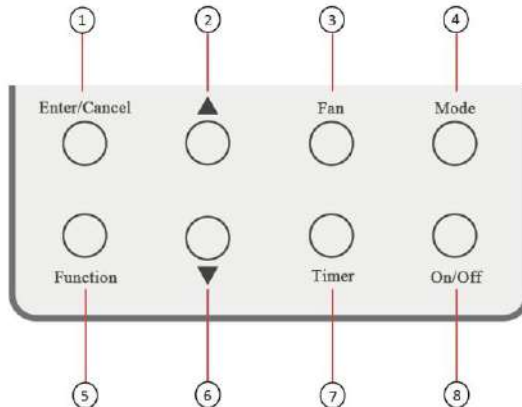

Figure 2.1 External View of Press Buttons

2.2 Function Instructions to the Press Buttons

Table 2.1 Function Instructions to the Press Buttons

No.	Press button	Interpretation
①	Enter/Cancel	It is used to select the desired function or cancel the selected function.
②	▲	(1) It is used to adjust the running temperature of the indoor unit among 16~30°C. (2) It is used to adjust the timer among 0.5~24 hours.
⑥	▼	(3) It is used to set the temperature for energy saving. (4) It is used to switch between the modes of "Imperative Quiet" and "Auto Quiet".
③	Fan	It is used to adjust fan speed settings
④	Mode	(1) It is used to set the mode of "Cool", "Dehumidify", "Fan", and "Heat". (2) When the "Save" function has been activated, it is used to switch between the mode options of "Heat" and "Cool". (3) When "Hour-minute timing" has been activated, press "Mode" to switch between a start timer and a stop timer.
⑤	Function	It is used to switch among the functions of "Sleep", "Light", "Turbo" and "Dry", etc.
⑦	Timer	It is used to set the timer.
⑧	On/Off	It is used to start/stop the indoor unit.
④ Mode and ② ▲	Memory	In the "Off" status of the unit, press "Mode" and ▲ simultaneously for five seconds to activate or deactivate the "MEMORY" function. (Once this function is activated, the unit with power failure will resume the previous set status after powered on again; otherwise it will go to the "Off" status.)

Wired Controller for Exposed FCUs

No.	Press button	Interpretation
④Mode and ⑥▼	Switchover between °C and °F	In the OFF status, by pressing “Mode” and ▼ at the same time for five seconds, the displayed temperature unit will be switched between °C and °F.
②▲and⑥▼	Child lock	By pressing ▲ and ▼ for five seconds, the child lock will be activated or deactivated.
③Fan and ④ Mode	Swing	When cassette type FCUs are on, press “Fan” and “Mode” for five seconds to see a swing setting page.
②▲and ⑦ Timer	Save	When the unit is off, press “Timer” and ▲ for five seconds to set energy saving function.
⑥▼and ⑦ Timer	Clock	When “Hour-minute timing” has been chose, on the “On” or “Off” page, press “Timer” and ▼ for five seconds to see set the clock.
④Mode and ⑦Timer	Module state	On the “On” or “Off” page, press “Mode” and “Timer” for five seconds to see module state page.
① Enter/Cancel and ④Mode	BMS address	When the unit is off, press “Enter/Cancel” and “Mode” for five seconds to set energy saving function.
⑤Function and ⑦Timer	Commissioning	When the unit is off, press “Function” and “Timer” for five seconds to enter the commissioning page and see a parameter code at the temperature display area and a parameter setpoint at the timer area. Press “Mode” to adjust the set item. Press ▲ or ▼ to determine a specific value.

3 Installation of the Wired Controller

3.1 Dimensions and Parts of the Wired Controller

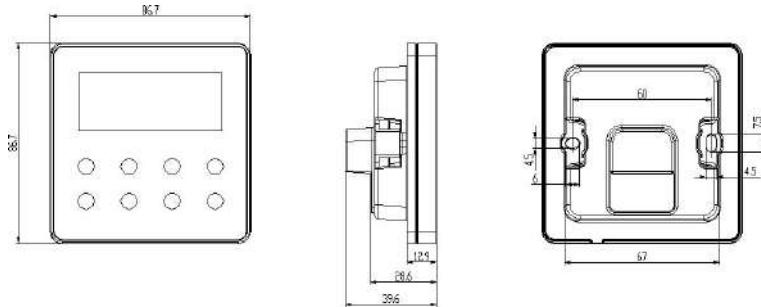

Figure 3.1 Dimensions of the Wired Controller

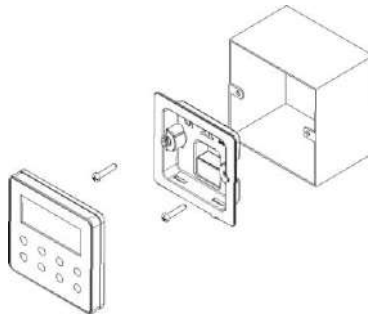

Figure 3.2 Parts of the Wired Controller

No.	①	②	③	④
Name	Wired controller	Screw M4×25	Installation box	Junction box built inside the wall
Quantity	1	2	1	Prepared by the user

3.2 Installation Location and Requirements

- (1) Do not install the wired controller where it is moist or there is direct sunlight.
- (2) Do not install the wired controller near high-temperature objects or it will be likely to suffer water splash.
- (3) Do not install the wired controller facing the window, as it will be interfered once the neighbor uses the wired controller with the same model.
- (4) Before installation, cut off the power supply for the electric lines buried inside the installation hole. No power supply is allowed during the whole installation.
- (5) In case of electromagnetic interference and even failed operation of the unit, the following points should be paid attention during wiring.
 - 1) Be sure the communication lines are connected to the correct ports; otherwise it would lead to communication error.
 - 2) The communication lines should be separated with the power lines and the connection lines between the indoor and outdoor units with at least a distance of 20cm, otherwise it would lead to failed communication.
 - 3) When the unit is installed where it is likely to suffer electromagnetic interference, the communication lines should be the shielded twisted pairs.

3.3 Network Connection Instructions

Network connection between indoor units and the wired controller:

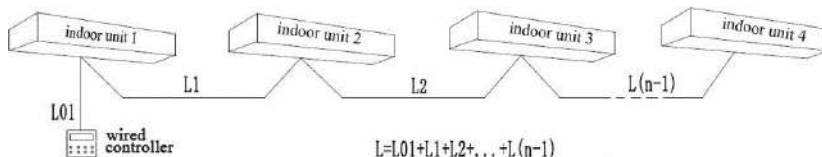

A wired controller is allowed to be connected with any indoor unit while it achieves group control. The connected indoor unit must be the in the same unit series.

A wired controller can only control no more than 10 wall-mounted type FCUs, less than 32 cassette and floor ceiling types. The DIP switch address is unique and all the units must be operating with a same network.

3.4 Installation Instructions

Use a proper controller signal line: four-core signal line (diameter \geq 0.75mm, length $<$ 30m and 8m recommended length). Installation steps are shown below.

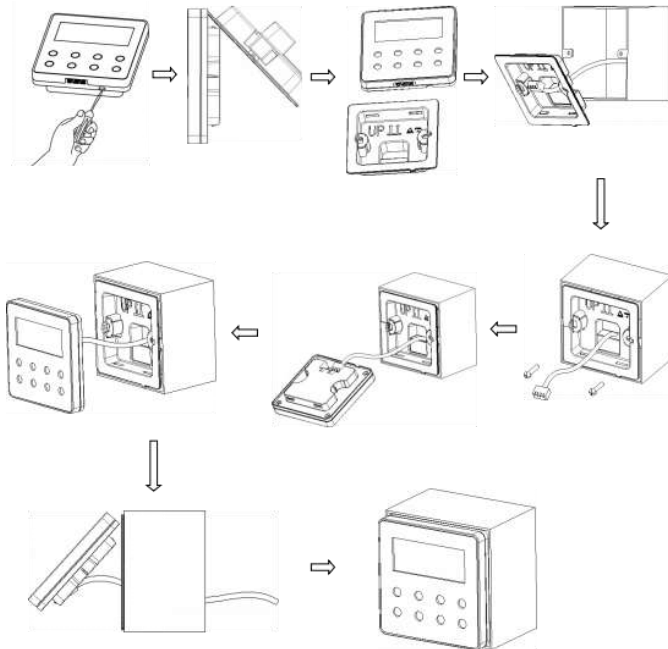

Figure 3.3 Installation Diagram of the Wired Controller

See the following statements for brief instructions to installation of the wired controller.

- (1) Cut off the power supply for the indoor unit and no power supply is allowed during the whole installation process.
- (2) Pull out the four-core twist pairs buried inside the installation hole and then let them go through the wring hole at the back of the base plate of the wired controller.
- (3) Fix the base plate on the wall with screws M4*25.
- (4) Connect the four-core twisted pairs to the four-core socket at the back of the wired controller.
- (5) Fix the front panel and the base plate of the wired controller.

3.5 Detachment of the Wired Controller

See Figure 3.4 for more details about detachment.

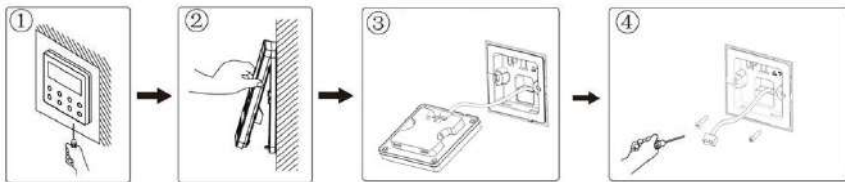

Figure 3.4 Detachment of the Wired Controller

4 Operation Instructions

4.1 On/Off Setting

In the “Off” status of the unit, press “On/Off” to start the unit.

In the “On” status of the unit, press “On/Off” to stop the unit.

See Figure 4.1 and 4.2 for the “On” and “Off” page of the wired controller.



Figure 4.1 “On” Page



Figure 4.2 “Off” Page

4.2 Mode Setting

In the “On” status, each press on “Mode” can change the modes circularly.

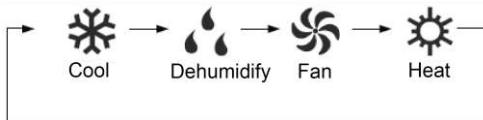

4.3 Temperature Setting

In the “On” status, press ▲ and ▼ to increase or decrease the set temperature. A long-time press will make the temperature go up or down by 1°C/°F per 0.3 second.

Temperature Range: 16°C~30°C.

4.4 Fan Speed Setting

In the “On” status, each press on “Fan” will change the fan speed as shown in Figure 4.3.

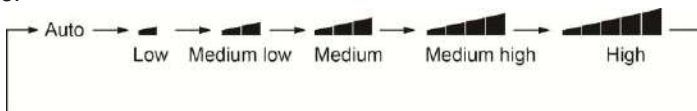

Figure 4.3 Fan Speed Setting

As the wired controller for cassette type or floor ceiling type FCUs starts up, press “Fan” and then the fan speed will switch in sequence as shown below.



Note: in the **“Dehumidify”** mode, the fan speed will be automatically be set to **“Low”** and cannot be changed.

4.5 Commissioning

When the unit is **“Off”**, press **“Function”** and **“Timer”** simultaneously for five seconds to call out the commissioning menu. Press **“Mode”** to select the desired submenu and then press ▲ or ▼ to set the parameter.

Press **“Enter/Cancel”** to save all the settings and exit. The screen will return to the **“Off”** page without any operation in 20 seconds, not saving any data that were set.

Code	Name	Options	Default
00	Ambient Temperature Sensor	01: Return air temperature sensor 02: Wired controller sensor 03: The return air temperature sensor is selected under the “Cool” , “Dehumidify” or “Fan” mode. The temperature sensor of the wired controller is selected under the “Heat” mode	03
01	Anti-Cold/Hot Air Function	01: Activate 02: Deactivate	01

Wired Controller for Exposed FCUs

Code	Name	Options	Default
03	Remote monitoring or central controller	00: Central controller 01: Remote monitoring	01
04	Temperature correction of the return air temperature sensor	00: 0°C 01: 1°C 02: 2°C ... 15: 15°C	02
05	Timer	00: Common timing 01: Hour-minute timing	01
06	Repetition of hour- minute timing (only available when hour and minute timing is chosen)	00: Once 01: Every day	01

4.6 Timer Setting

The controller has a common timer and an hour-minute timer. The hour-minute timer is set by default. See 4.5 for commissioning of the timer.

4.6.1 Common Timer

In the “**On**” status, you can set a stop timer; in the “**Off**” status, you can set a start timer.

Activate a start timer: a start timer has not been set in the “**Off**” state. Press “**Timer**” to see “**xx.x HOUR**” appearing on the screen with **ON** and “**HOUR**” flashing. Press ▲ or ▼ to adjust time. Press “**Timer**” in conformation.

Activate a stop timer: a stop timer has not been set in the “**Off**” state. Press “**Timer**” to see “**xx.x HOUR**” appearing on the screen with **OFF** and “**HOUR**” flashing. Press ▲ or ▼ to adjust time. Press “**Timer**” in conformation.

Deactivate the timer: as a timer has been set, press “**Timer**” to cancel it with “**xx.x HOUR**” not displayed.

See figure 4.4 for setting a stop timer in an “**Off**” status.



The timer has not been set

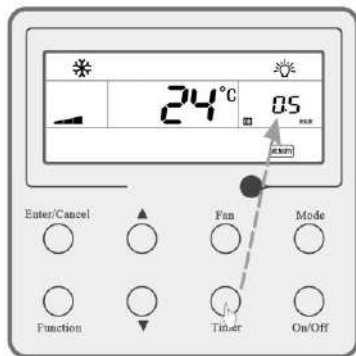

Press "Timer" to go to the setting status

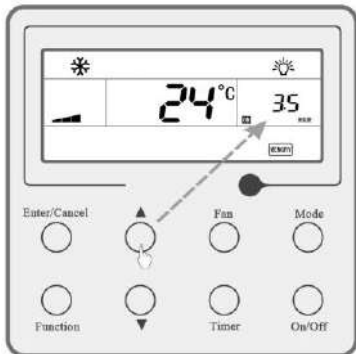

Press ▲ or ▼ to adjust a stop timer

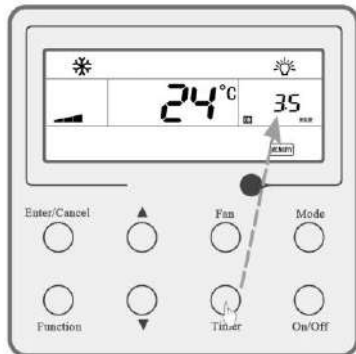

Press "Mode" to finish this setting

Figure 4.4 How to Set a Stop Timer

See figure 4.5 for deactivating a timer:

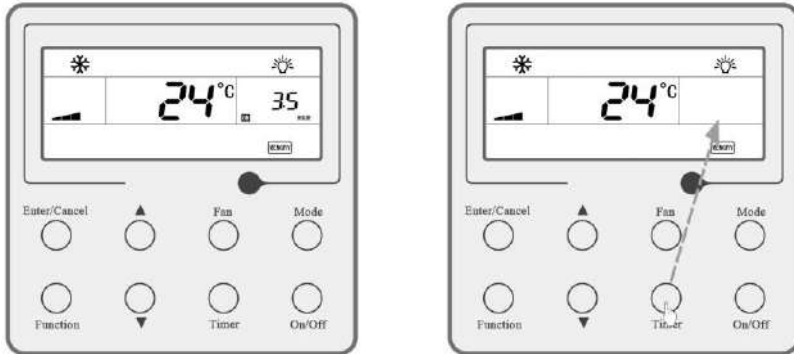

A timer has been set in the “On” status Press “Timer” to cancel the timer

Figure 4.5 How to Cancel a Timer in the “On” Status

Timer range: 0.5~24 hours

Keep pressing ▲ or ▼ to adjust time.

⚠ NOTES

- (1) In the “On” status, you can set a stop timer; in the “Off” status, you can set a start timer.
- (2) When setting a timer, press “Function” to exit.

4.6.2 Clock

Clock setting permission: when an hour-minute timer has been set, in the “On” and “Off” status, the clock appear at the timer area on the screen. Then you can set the clock.

On the “On” or “Off” page, press ▼ and “Timer” for five seconds to go to the clock setting page with the hour of “xx:xx” (“hour”:“minute”) flashing. Use ▲ or ▼ to determine the hour and “Enter/Cancel” to set the minute. While the minute of “xx:xx” (“hour”:“minute”) is flashing, use ▲ or ▼ to determine the minute and “Enter/Cancel” to finish timing and return to the “On” or “Off” page.

See figure 4.6 for setting the clock:



“On” or “Off” page

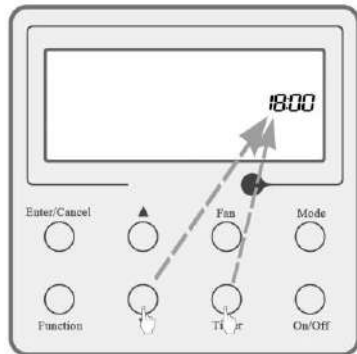

Press ▼ and “Timer” to go to the clock setting page

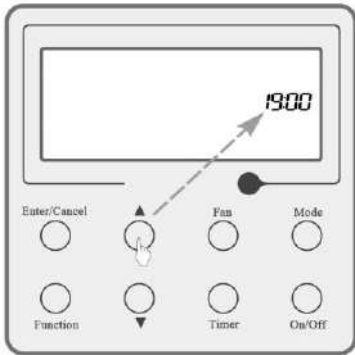

Use ▲ or ▼ to determine the minute

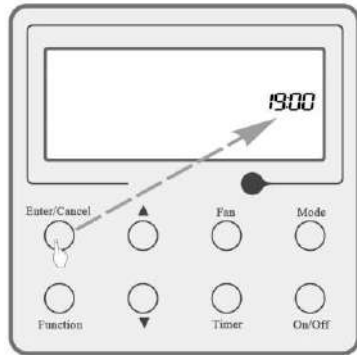

Press "Enter/Cancel" to set the minute

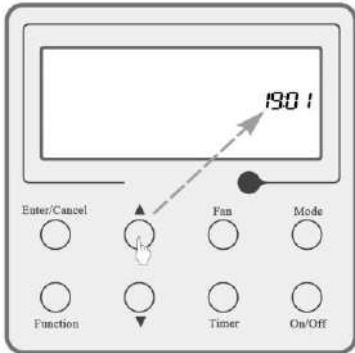

Use ▲ or ▼ to determine the minute

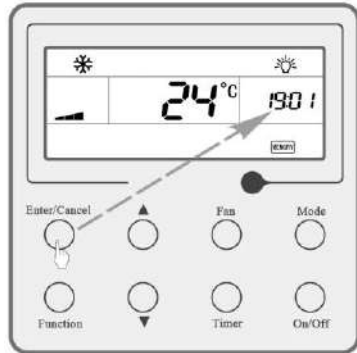

Press "Enter/Cancel" to finish all settings

Figure 4.6 How to Set the Clock

Timer Range: 00:00~23:59



Each press on ▲ or ▼ will increase or decrease the timer.



NOTES

- (1) In the clock setting, press “On/Off” to cancel the settings and return to the “On” or “Off” page.
- (2) In the clock setting, when there is no any operation in 20 seconds, the controller will quit this setting, with the setting data not saved.



4.6.3 Hour-minute Timer

On the “On” or “Off” page, press “**Timer**” to set the time for starting or stopping the unit.

Activate a start timer: the timer has not been set. Press “**Timer**” to see a start timer setting page. When  appears, **ON** as well as the hour of “**xx:xx**” (“hour”:“minute”) flash. Use ▲ or ▼ to determine the hour and “**Enter/Cancel**” to set the minute. While the minute of “**xx:xx**” (“hour”:“minute”) is flashing, use ▲ or ▼ to determine the minute and “**Enter/Cancel**” to finish timing and return to the “On” or “Off” page.  and **ON** are constantly displayed on the screen to indicate the start timer is activated.

Activate a stop timer: the timer has not been set. Press “**Timer**” to see a start timer setting page. Press “**Mode**” to see a stop timer setting page. When  appears, **OFF** as well as the hour of “**xx:xx**” (“hour”:“minute”) flash. Use ▲ or ▼ to determine the hour and “**Enter/Cancel**” to set the minute. While the minute of “**xx:xx**” (“hour”:“minute”) is flashing, use ▲ or ▼ to determine the minute and “**Enter/Cancel**” to finish timing and return to the “On” or “Off” page.  and **OFF** are constantly

displayed on the screen to indicate the stop timer is activated.

Deactivate the timer: as a start timer has been activated, press **“Timer”** to see a start timer setting page. When you press that key again, **ON** and  disappear. The start timer is disabled. As a stop timer has been activated, press **“Mode”** to see a stop timer setting page. When you press that key again,  and **OFF** disappear. The stop timer is canceled.

See Figure 4.7 for setting a start timer in the **“On”** status of the unit.



The timer is not set.

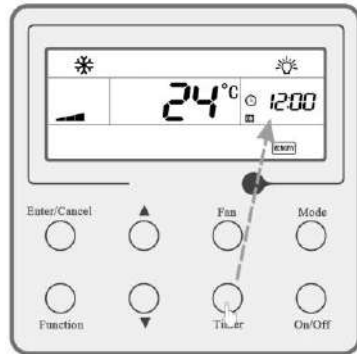

Press **“Timer”** to go to the setting status

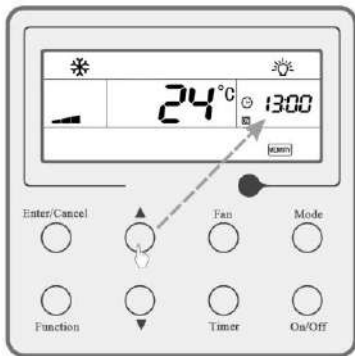

Press “▲” or “▼” to determine the hour

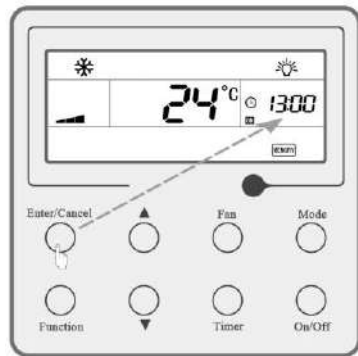

Press “Enter/Cancel” key to set minute

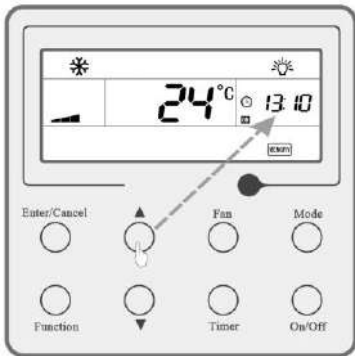

Press “▲” or “▼” to determine the minute

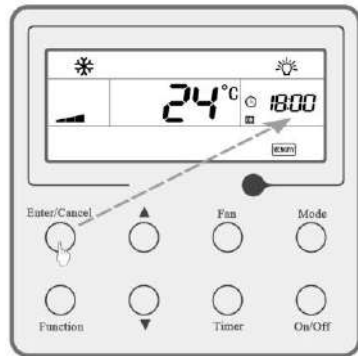

Press “Enter/Cancel” key to finish timing

Figure 4.7 How to Set a Start Timer

See Figure 4.8 for how to cancel the timer in the “On” status of the unit.

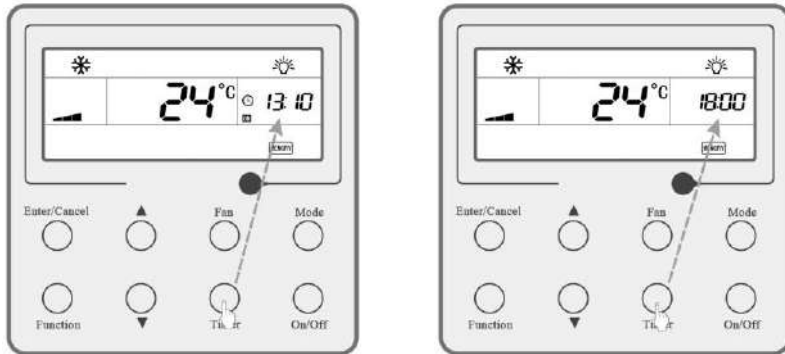

The timer is set when the unit is turned on Press “Timer” to cancel the setting

Figure 4.8 How to Cancel the “Timer”.



Timer Range: 00:00~23:59



Each press on ▲ or ▼ will increase or decrease the timer.

⚠ NOTES

- (1) When the start timer is the same with the stop timer, the controller act on the stop timer.
- (2) When setting a timer, press “On/Off” key to exit.
- (3) When the timer is set, the clock time, ⌚, **ON** and **OFF** are displayed.

4.7 Sleep Function Setting

How to activate the **“Sleep”** function: when the unit is **“On”** and the **“Sleep”** function is deactivated, press **“Function”** to go to the setting state of the **“Sleep”** function with the symbol  flashing. After that, press **“Enter/Cancel”** to make a conformation and then the symbol  will stop flashing.

How to deactivate the **“Sleep”** function: when the unit is **“On”** and the **“Sleep”** function is activated, press **“Function”** to go to the setting state of the sleep function with the symbol  flashing, after that, and then press **“Enter/Cancel”** to make a confirmation and the symbol  will disappear.

NOTES

- (1) The function is defaulted to be **“Off”** upon restoration of power.
- (2) This function is unavailable in the **“Fan”** mode.
- (3) Once the **“Quiet”** function has been activated, it will keep the same no matter if the sleep function is activated or deactivated.

4.8 Turbo Setting

“**Turbo**” function: it is a function to make the temperature of the conditioned air approach the set value rapidly through high-speed running of the fan in either “**Cool**” or “**Heat**” mode.

How to activate the “**Turbo**” function: in the “**Cool**” or “**Heat**” mode, when the “**Turbo**” function is “**Off**”, press “**Function**” to go to the setting status of the “**Turbo**” function with the symbol “**Turbo**” flashing. Press “**Enter/Cancel**” to make a confirmation and then the symbol stops flashing is constantly displayed.

How to deactivate the “**Turbo**” function: when the unit is “**On**” and the “**Turbo**” function is activated, press “**Function**” to go to the setting state of the “**Turbo**” function with the symbol “**Turbo**” flashing, after that, press “**Enter/Cancel**” to make a confirmation and then the symbol “**Turbo**” disappear.

NOTES

- (1) The “**Turbo**” function will be memorized upon restoration of power. In the “**Dehumidifying**” and “**Air supply**” modes, this function is unavailable, with the symbol “**Turbo**” not displayed.
- (2) When the “**Quiet**” function has been activated, the “**Turbo**” function will be deactivated.
- (3) The “**Turbo**” function will be deactivated when changing the fan speed.
- (4) The “**Turbo**” function is not available for floor ceiling types.

4.9 Save Function Setting

This function is intended to save energy through limiting the temperature range in “Cool”, “Dehumidify” or “Heat” mode.

The set temperature range for energy saving in the “Cool” or “Dehumidifying” mode is from the set point to 30°C.

The set temperature range for energy saving in the “Heat” mode is from 16°C to the set point.

See Figure 4.9 for how to set the “Save” function.

In the “Off” status, by pressing “Timer” and ▲ for five minutes, the controller will go to the “Save” setting status, with “SAVE” and the icon for the cooling mode displayed. In the temperature area, the upper and lower temperature limits will be displayed, which can be changed by ▲ and ▼ (the setting range is 16°C~30°C). In this case, by pressing “Mode”, the operation mode will be switched over between “Heating” and “Cooling”. For the cooling only unit, only lower limit is available. In the setting process, by pressing “Enter/Cancel”, the setting temperature and status for each mode will be saved and the “Save” function will be activated.

When this function has been activated, in the “Off” status, by pressing “Timer” and ▲ for five minutes, this function will be deactivated.



The **“Save”** function is not activated when the unit is turned off.

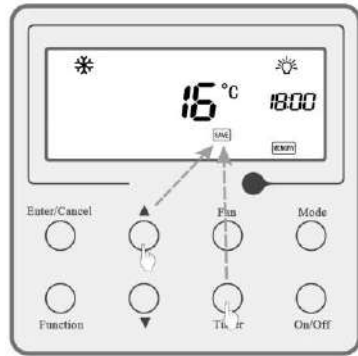

Press **“Timer”** and **▲** for five minutes. to go to the **“Save”** setting for cooling.

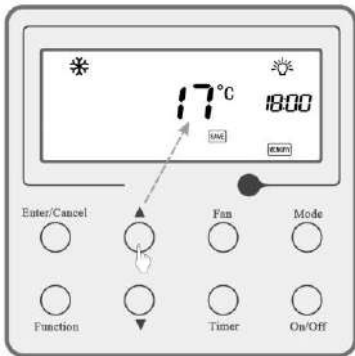

Press **“▲”** or **“▼”** to adjust the temperature set point.

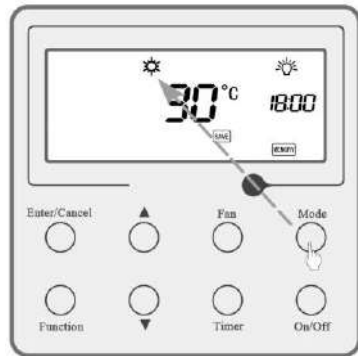

Press **“Mode”** to switch to the **“Save”** setting for heating



Press “▲” or “▼” to adjust the temperature set point



Press “Enter/Cancel” to activate/deactivate the “Save” function

Figure 4.9 How to Set the Save Function

△ NOTES

- (1) When this function is activated in the “Auto” mode, it will work for each corresponding mode. Once it is activated, the “Sleep” function will be deactivated.
- (2) In the “Save” setting, when there is no any operation in 20 seconds, the controller will quit this setting, with the setting data not saved.
- (3) The “Save” function will be memorized when the unit is powered on again after power failure.
- (4) The initial lower temperature limit in the cooling mode is 16°C and the initial upper temperature limit is 30°C in heating mode.
- (5) When the “Save” function is activated, if the set temperature in each mode is higher than

⚠ NOTES







the corresponding temperature limit for energy saving, the set temperature will forcibly go to the temperature limit.



- (6) When the temperature set point goes to the upper limit or lower limit for the “**Save**” function, then by pressing “▲” or “▼”, or the temperature set point is higher than the range for the “**Save**” function, the symbol “**SAVE**” will flash for three times and the beeper will sound for twice (each lasts for 50ms with an interval of 50ms).

4.10 Quiet Function Setting

Wall-mounted type FCUs have the “**Quiet**” function, but the cassette and floor ceiling types do not have it.

There are two options for this function: “**Imperative Quiet**” mode and “**Auto Quiet**” mode.

How to activate the “**Quiet**” function: press “**Function**” to go to the setting state with the symbol  or  flashing. Press ▲ or ▼ to switch between  or  and “**Enter/Cancel**” to cancel the “**Quiet**” function,  or  not displayed.

How to deactivate the “**Quiet**” function: when the “**Quiet**” function is activated, press “**Function**” to go to the setting state with the symbol  or  flashing. Press “**Enter/Cancel**” to deactivate the “**Quiet**” function and corresponding icon will not be displayed.

NOTES

- (1) If you change the fan speed, the “**Quiet**” function will exit.
- (2) When the “**Auto Quiet**” mode is on, the unit is operating according to the difference between the indoor temperature and the set point.
- (3) When the “**Air supply**” and “**Dehumidifying**” function are unavailable when the “**Quiet**” function is activated. The “**Quiet**” function is off by default upon restoration of power.
- (4) The “**Turbo**” function will be canceled when the “**Quiet**” function is activated.
- (5) If you switch between modes or stop the unit, the “**Quiet**” function will be cancelled.

4.11 X-Fan Setting

Drying function: if unit is turned off under “**Cooling**” or “**Dehumidifying**” mode, the evaporator of the indoor unit is dried automatically to prevent mildew.

In “**Cool**” and “**Dehumidifying**” modes, press “**Function**” to choose X-fan with

 on the screen flashing. Press “**Enter/Cancel**” to activate the function.

The “**Drying**” function is activated. Press “**Function**” to choose X-fan with  on the screen flashing. Press “**Enter/Cancel**” to cancel the function.

Note: “**Drying**” function is not available in “**Air supply**” or “**Heat**” mode.

4.12 Light Setting

If you activate the “**Light**” function, the current operation state will be seen on the unit display panel with its backlight on. Deactivate the “**Light**” function to turn off the backlight of the unit display panel.

In “Cool”, “Heat” or “Dehumidify” mode, press “Function” to go to the “Light” setting page with  flashing. Press “Enter/Cancel” to activate the “Light” function.

When the “Light” function is activated, press “Function” to go to the “Light” setting page with  flashing. Press “Enter/Cancel” to cancel the “Light” function.

4.13 Module State

In the “On” or “Off” status, on the “On” or “Off” page, press “Timer” and “Mode” for five seconds to go to the module state page. Module numbers appear at the center of the screen (no more than 10 modules for wall-mounted type FCUs have and no more than 32 modules for cassette type FCUs). Press ▲ and ▼ to switch module numbers. Connection state of modules appears on the right area of the screen. “1” indicates normal connection and “0” non-connection or non-existence. The page will exit without any key press on the screen in 20 seconds or by pressing “Enter/Cancel”.

See figure 4.10 for checking the module state.



“On” or “Off” page

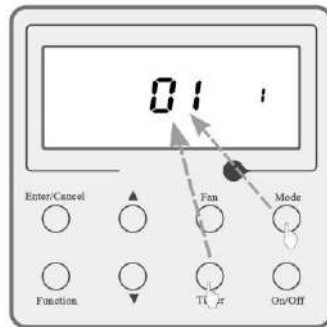

Press “**Timer**” and “**Mode**” go to the module state page.



Press ▲ and ▼ to switch the module numbers.



Press “**Enter/Cancel**” to exit.

Figure 4.10 How to Check the Module State

4.14 Swing Setting

For cassette type FCUs: in the “On” status, press “Fan” and “Mode” for five seconds to go to the swing setting page with motor numbers at the center of the screen. Press “Mode” to switch motor numbers. Press ▲ and ▼ to activate or deactivate the “Swing” function. Use “Enter/Cancel” to save all the settings and return to the last page. When there is a swing motor starting,  will appear on the home page. When setting the “Swing” function, the screen will return to the “On” page without saving any data if there is not any key press in 20 seconds.

For wall-mounted type FCUs: in the “On” status, when “Cool”, “Dehumidify” or “Heat” mode is on, press “Function” to go to the swing setting page. Press ▲ to change swing angles in sequence as follows.

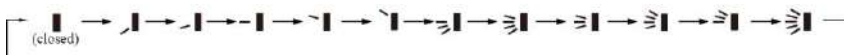

Press ▼ to change swing angles like this:

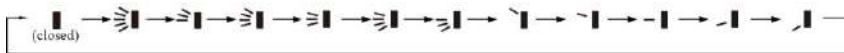

Press “Enter/Cancel” to save the setting above and start swinging. After “Swing” function is on, each mode can run with the function.

4.15 BMS Address Setting

In the “**Off**” status, press “**Enter/Cancel**” and “**Mode**” for five seconds to go to the BMS address setting page with module numbers at the center of the screen (no more than 10 modules for wall-mounted type FCUs have and no more than 32 modules for cassette type FCUs). The address set points appear at the timer area. Press “**Mode**” to switch module numbers. Press ▲ and ▼ to adjust MBS addresses. Use “**Enter/Cancel**” to save all the settings and return to the last page. When BMS address is being setting, if there is not any key press in 20 seconds, the screen will return to the “**Off**” page without saving any data.



4.16 Ambient Temperature

On the “**On**” or “**Off**” page, press “**Function**” and ▲ for five seconds to go to the ambient temperature page. When you choose “**Return air temperature sensor**”, ambient temperatures of all modules are accessible. Module numbers appear at the center of the screen (no more than 10 modules for wall-mounted type FCUs have and no more than 32 modules for cassette type FCUs). Press “**Mode**” to switch module numbers. When you choose “**Wired controller sensor**”, just the ambient temperature indicated by the wired controller sensor is accessible. The page will exit without saving any data if there is not any key press in 20 seconds.

4.17 Other Functions

4.17.1 Child Lock

Lock Function: It can lock the keypad and then the press on any other keys will get no response.

Whatever the unit is “**On**” or “**Off**”, press ▲ and ▼ simultaneously for five seconds to activate the “**Lock**” function and the symbol  will appear. And then another press on them will deactivate this function and the symbol  will disappear.

The “**Lock**” function will be memorized when the unit is powered on again after power failure.

4.17.2 Memory

How to switch to the “**Memory**” function: when the unit is “**Off**”, press “**Mode**” and ▲ simultaneously for five seconds to activate/deactivate the “**Memory**” function. Once the function is activated, the symbol will be displayed on the LCD.

“**Memory**” Function: when the “**Memory**” function is activated for the wired controller, the unit resume the status before powered off when it is powered on again; otherwise the unit will go to the “**Off**” status when it is powered on again.

NOTES



Please don't cut down the power after the content changes in five seconds, or it may fail to save the content.

4.17.3 Switchover between °C and °F

In the “Off” status, by pressing the “Mode” and ▼ for five seconds, the controller will be switched over between °C and °F.

4.17.4 Gate Control

When the gate control is effective, the unit will work with the card inserted in and will be shut down with the card drawn out.

When the card is drawn out, the unit will be shut down and the symbol  will appear; when the card is inserted in again, the symbol  will disappear. If the “Memory” function has been activated before you draw out the card, upon reinsertion of the card, the last screen of data that was collected will be displayed and the controller will continue to work; if not, upon reinsertion of the card, you will see the “Off” page on the screen.

NOTES

- (1) The long-distance monitoring is always activated no matter the card is being inserted or not.
- (2) The displayed symbol  indicates that the unit cannot be controlled through the keys.

4.17.5 Remote Shield

When the wired controller is locked by long-distance control, a press on any keys or the operation through the remote controller is unavailable with the symbol  displayed.

When functions including “**On/Off**”, “**Mode**” and “**Temperature**” are shielded, a press on these keys of the wired controller or the operation through the wireless controller to change on/off status, modes and temperatures will be unavailable, with  flashing. But it is still available to check parameters by combination keys. When the functions are not shielded, these keys to change on/off status, modes and temperatures will be available.

5 Error Display

When a system error arises, its error code will be displayed in the temperature zone. While if several errors occur at the same time, their codes will be displayed circularly.

Once an error arises, please shut down the unit and contact the professional technician.

As shown in figure 5.1, it indicates the communication error.



Figure 5.1 Communication error

Note: when errors, failures or faults occur, the current time is not displayed and the “**Timer**” function unavailable.

Error List

Wall-mounted type FCU:

Error code	Error description
E6	Communication error
C5	Jumper error
F0	Indoor temperature sensor error at the return air inlet
F1	Temperature sensor error of the cooling coil
F5	Ambient temperature sensor error at the wired controller
E8	DC motor locked-rotor protection

Cassette type FCU:

Error code	Error description
E6	Communication error
E9	Water overflow protection
F0	Indoor temperature sensor error at the return air inlet
F1	Temperature sensor error of the cooling coil 1
FE	Temperature sensor error of the cooling coil 2
E0	Water pump error



GREE ELECTRIC APPLIANCES, INC. OF ZHUHAI

Add: West Jinji Rd, Qianshan, Zhuhai, Guangdong, China, 519070

Tel: (+86-756) 8522218

Fax: (+86-756) 8669426

E-mail: global@cn.gree.com www.gree.com



600005062108